

TUXEL[®] -VIB

Electromagnetische Trilgoten

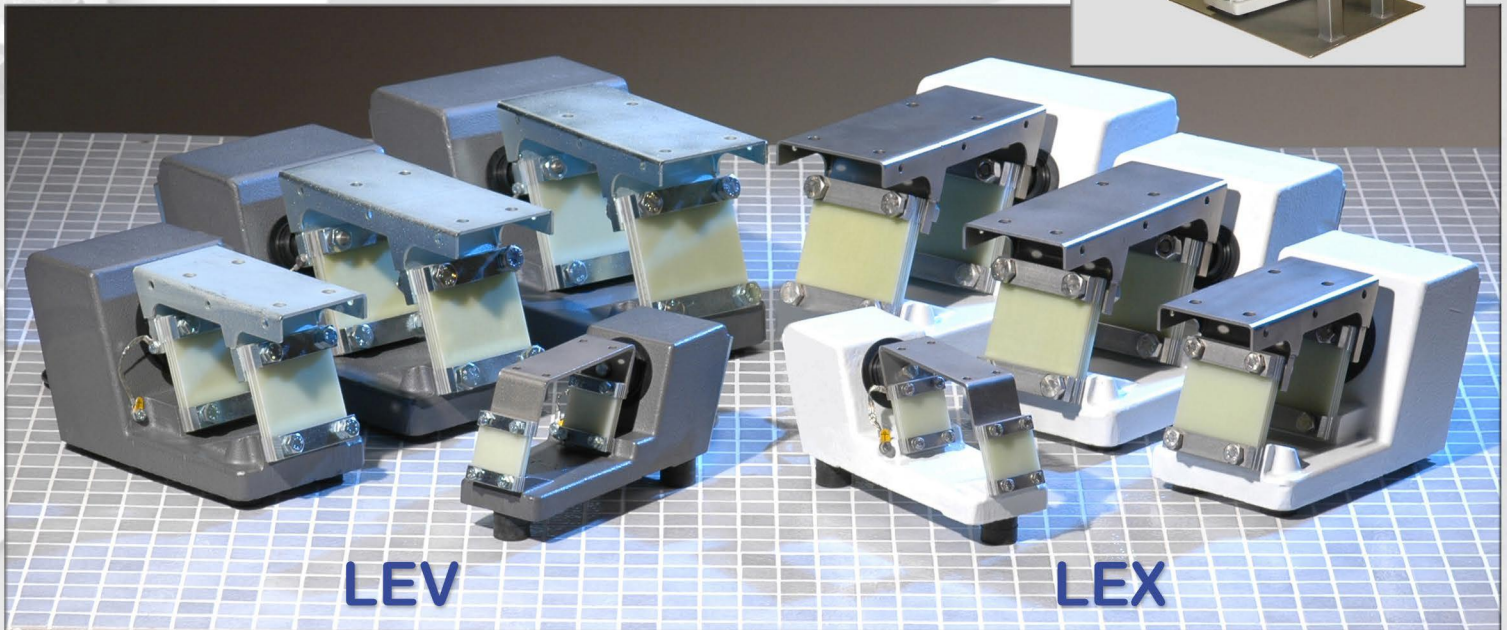

Beantwoord aan de spits standaard van de ALIMENTATIE,
FARMACEUTISCHE, CHEMISCHE industrie, enz...

POLYURETHANE bekleding FDA agreement (alleen LEX type)

Elektromagnetisch WATERDICHT systeem IP67

Veren in glasvezel, LEVENSLANGE WAARBORG

Alle metalen stukken in INOX UITVOERING (alleen LEX type)

Optie :

certificatie  II 2 G D / T4 & Ex tD A21 IP67 T°109C

<http://www.tuxel-vib.com> info@tuxel-vib.com

AFMETINGEN VAN DE STANDAARD GOTEN

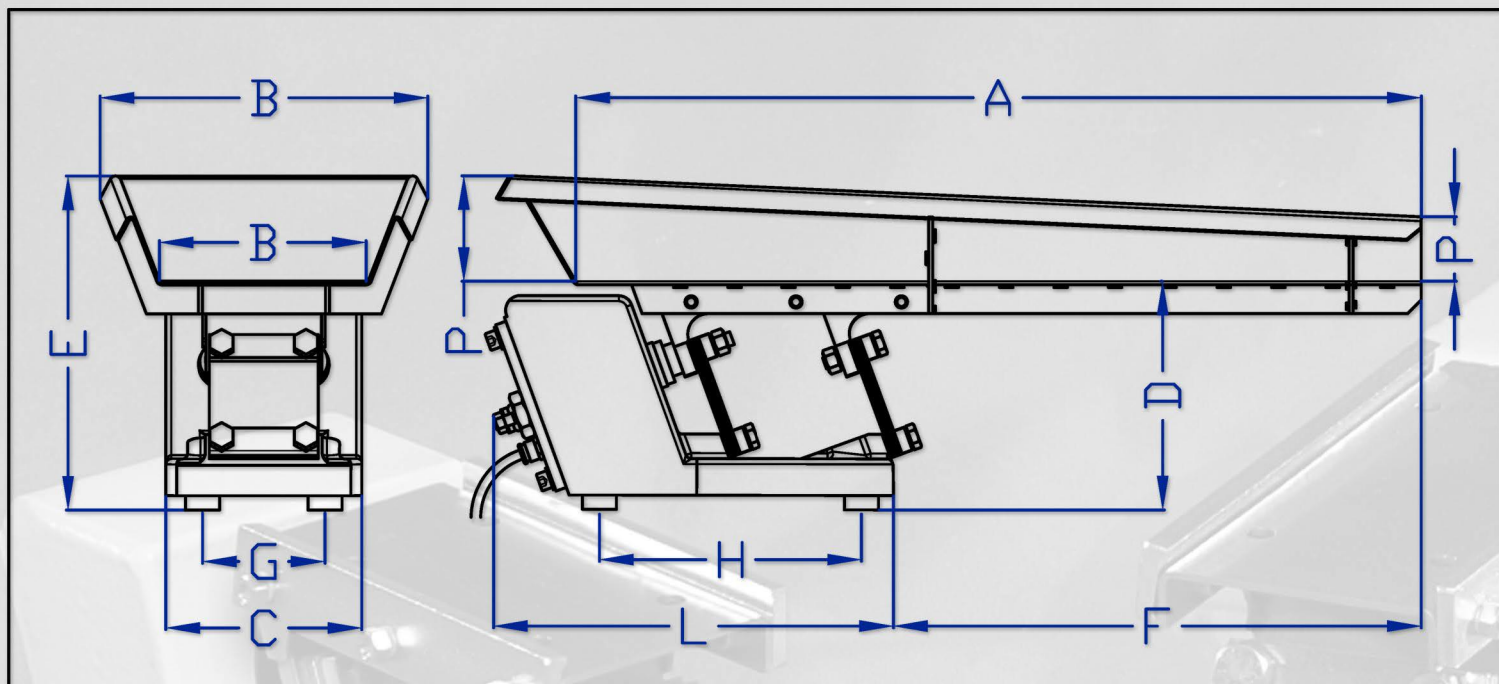

MODEL	A	B	C	D	E	F	G	H	L	P
LEV/X 1	305	93 40	75	118	180	120	50	160	230	50/25
LEV/X 2	500	194 125	122	142	202	313	75 80	142	248	60/45
LEV/X 3	700	241 150	144	168	252	468	90	193	298	80/50
LEV/X 4	800	301 200	178	180	267	545	100 120	195	310	90/50

Afmetingen in mm.

V 3.1

MODEL	MAXIMUM GEWICHT GOOT (TER INDICATIE)	DEBIET (T/u)*
LEV/X 1	1,5 kg	0,6
LEV/X 2	3 kg	2
LEV/X 3	7,5 kg	5
LEV/X 4	10 kg	7

*Berekend op basis van zand densiteit 1,6 t/m³

VORM VAN GOTEN

MET VLAKKE BODEM

Gewoon standaard type.
Constance gootbreedte.
Verticale of schuine flanken volgens de gewenste goot.

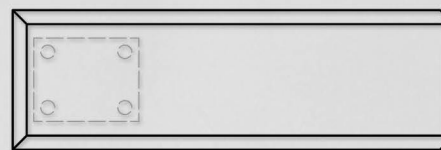
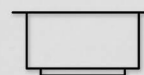

MET SCHUIN AFGEWERKT EINDE

Voor de toevoer van een transportband loodrecht op de goot van het toestel.

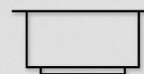

MET AFNEMENDE BREEDTE

Om de materialen op het ontladingspunt te concentreren.

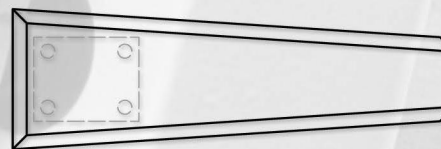

BUISVORMING

Voor dicht vervoer.
Maximum vulling half de buis.
Minder debiet dan die bekomen met de andere gootvormen.

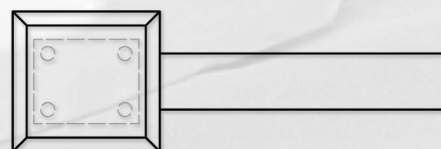

IN V VORM

Om een smalle en geconcentreerde stroom van materialen te bekomen bij het ontladingspunt.

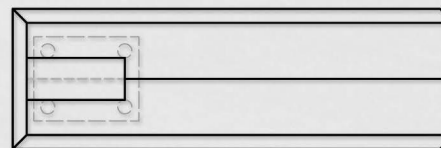

HALFCIRKELVORMIG

Gebruik voor het transport van lichte stukken en van ronde vorm.
Ook met deksel.

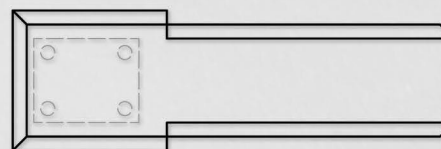

AFMETINGEN VAN DE TRILLER

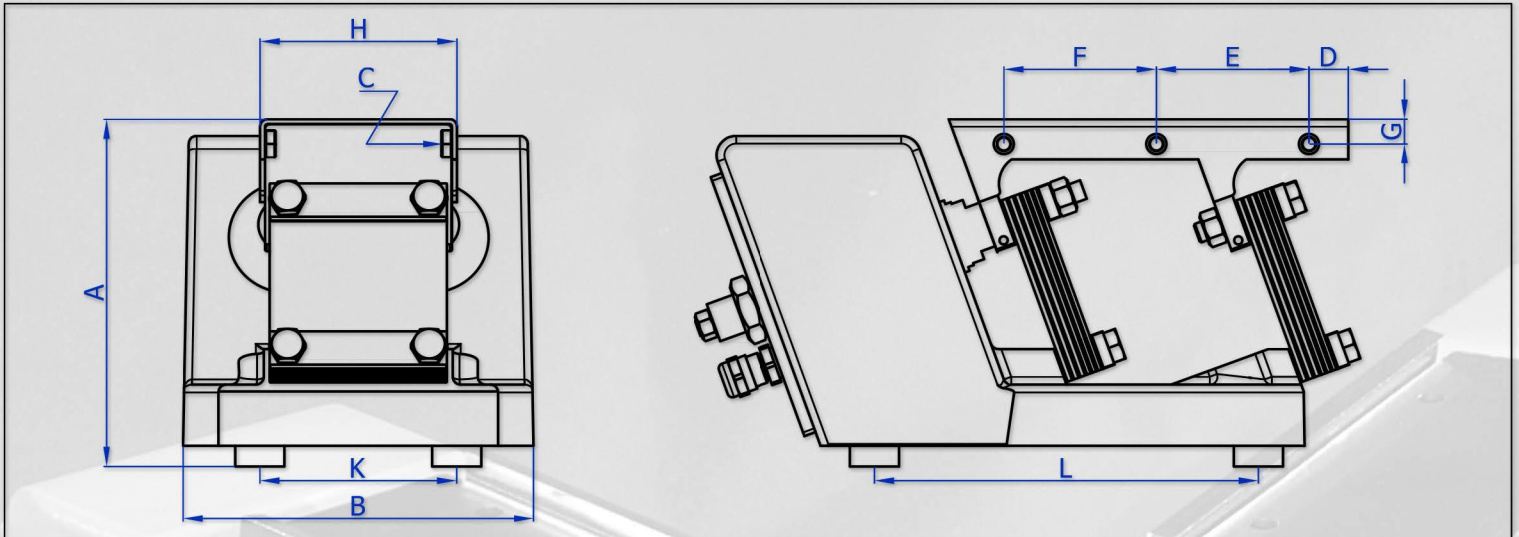

Enkel model LEV/X1

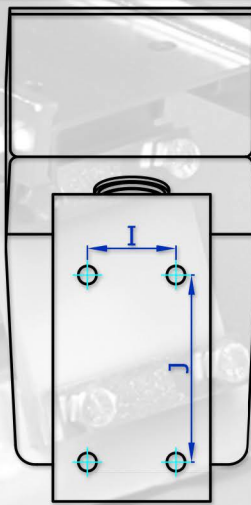
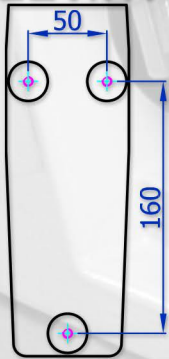

Type anti-tril-voeten

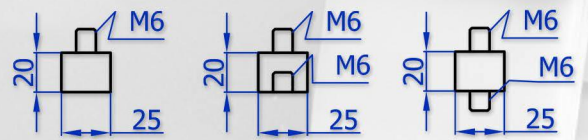

N°1

N°2

N°3

MODEL	GEWICHT	A	B	C	D	E	F	G	H	I	J	K	L
LE 1	4.6 kg	110 ±2	75	NA	NA	NA	NA	NA	40	25	76	tekening	tekening
LE 2	13.1 kg	145 ±2	122	M8	15	65	50	12	80	45	95	75 80	142
LE 3	19.1 kg	170 ±2	144	M10	20	77.5	77.5	12.6	90	45	120	90	193
LE 4	26.2 kg	175 ±2	178	M10	20	77.5	77.5	12.6	100	60	120	100 120	195

In mm.

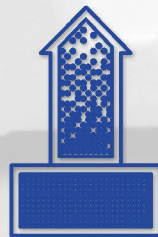

TUXEL® -VIB

Theodore Roosevelt street, 19-21
B-1030 Brussels

+32.2.735.38.95. +32.2.736.33.40.

<http://www.tuxel-vib.com> info@tuxel-vib.com

